

## Garlic as Anti-oxidants and Free Radical Scavengers

GEORGE C. YANG, PARVIN M. YASAEI AND SAMUEL W. PAGE

Center for Food Safety and Applied Nutrition, Food and Drug Administration  
200C St. S.W., Washington, D.C. 20204, U.S.A.

### ABSTRACT

The antioxidant activities of fresh garlic extracts and commercially available garlic products were evaluated using a recently developed technique for the determination of lipid hydroperoxides, initial intermediates in the lipid oxidation process. This measurement system uses reverse-phase column chromatography with chemiluminescence detection. Activity of the garlic preparations was compared to that of synthetic antioxidants. Protection against lipid oxidation provided by garlic extract was found to be concentration dependent, as was the protection provided by many synthetic antioxidants. In addition, garlic extract was also found to scavenge OH radicals, as evidenced by the reduction of the spin trap adduct in the presence of OH radicals.

**Key words :** Garlic, Anti-oxidants, Free Radical

### INTRODUCTION

Questions regarding the safety of synthetic antioxidants used in the preservation of food have led to increased interest and research on natural antioxidants. Several natural antioxidants, such as the mixed tocopherol, rosemary, ascorbic acid and ascorbyl palmitate, have been found to be less effective for food preservation as compared to that of the four major synthetic antioxidants, BHA, BHT, TBHQ and propyl gallate.

Garlic, *Allium sativum*, has been widely used as a flavoring agent in foods as well as a prophylactic and therapeutic medical agent since antiquity<sup>(1,2)</sup>. Garlic contains lipid soluble organosulfur compounds, such as S-allyl-L-cysteine sulfoxide (alliin). It also contains allinase, an enzyme which catalyzes the formation of diallyl

thiosulfinate (allicin). This enzymatic reaction is initiated by cutting or crushing the garlic bulb in air.

The components of garlic extract possess antioxidant activity. Alliin is an effective hydroxyl radical scavenger<sup>(3)</sup>. Extracts from garlic inhibited tumor growth in laboratory animals<sup>(4-9)</sup>. Radical oxygen processes are accordingly studied for their potential role in tumorigenesis and other diseases. Antioxidants, free radical scavengers, and simulators of superoxide dismutase and/or GSH peroxidase modulate oxidative challenges which lead to molecular events associated with tumor promotion.

In this study, we tested the anti-oxidant properties of garlic components by first incubating a standard lipid such as methyl linoleate and then measuring methyl linoleate hydroperoxide by an HPLC-chemiluminescence and detection technique as a mean for determining the

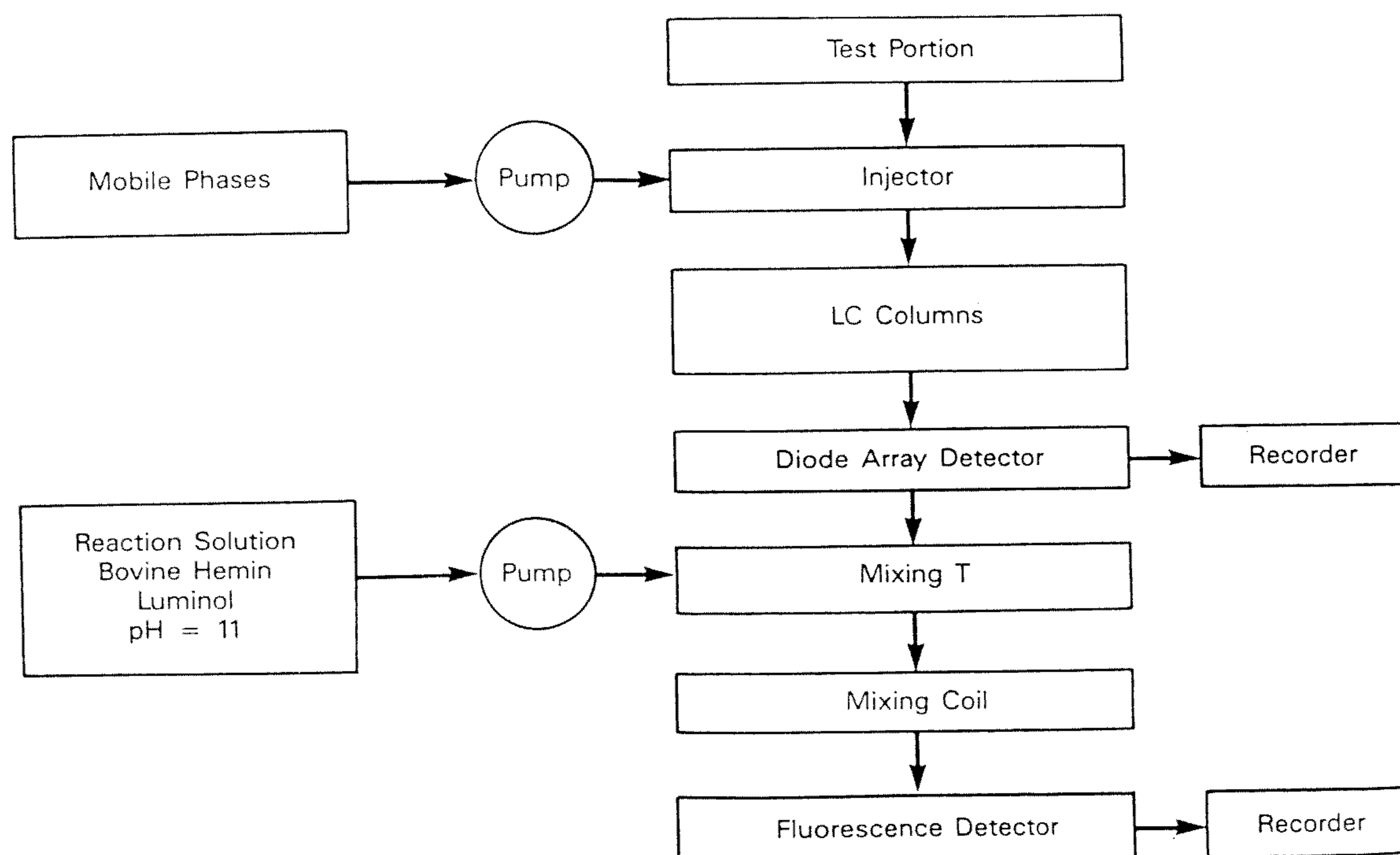
extent of lipid oxidation<sup>(10)</sup>. We also tested the radical scavenging ability of garlic extracts by measuring the Electron Paramagnetic Resonance (EPR) amplitude of the spin trap adduct of the radical species.

## MATERIALS AND METHODS

**Extraction of garlic:** Freshly peeled and chopped garlic (3 g) was blended with 30 ml of distilled water in a blender. The slurry was allowed to stand at room temperature for 5 minutes. The garlic pulp was filtered and extracted 3 times with 30 ml of methylene chloride. The combined methylene chloride fractions were rapidly evaporated to dryness on a rotary evaporator at 37°C.

A procedure for testing the antioxidant activity of various compounds or mixtures such as the garlic extract was developed in this study which measures methyl linoleate (ML) hydroperoxide, an oxidized intermediate ML, by post co-

lumn chemiluminescence technique. Aliquots of garlic extracts or test solution were dispensed into test tubes. ML, dissolved in acetonitrile solution, was then added to the same tubes and heated at elevated temperature (60-70°C) with constant stirring. A schematic diagram of the HPLC-chemiluminescence instrumentation is shown in Figure 1. For the HPLC separation of garlic extracts and lipid, a Waters HPLC system, Model 600E, with a Bio Rad Bio-sil 250 x 4mm, 5 $\mu$ , C18 column was used. Mobile phases were 40% methanol, 60% water with isocratic condition for garlic extract analyses. For lipid analysis, a gradient procedure was used with water:methanol:iso-propanol of 20:80:0 at t=0 and became 0:50:50 at t=10 min, and holding at this proportion until t=20 min. The flow rate was set at 1 ml/min. For UV detection after column, a Waters Model 991 photo-diode detector was fixed at 240 nm for garlic extract detection and 205 nm to monitor the parent methyl linoleate and 234 nm for monitoring conjugated diene. For post column reactions, the HPLC eluent ex-



**Figure 1.** Schematic diagram of the HPLC-chemiluminescence and instrumentation.

Journal of Food and Drug Analysis 1993, 1(4)

iting from the photo-diode detector was mixed with luminol solution <sup>(10)</sup> using a 100 $\mu$ l reaction loop at 1 ml/min, operating at room temperature. For the post column chemiluminescence detector, a Kratos fluorescence HPLC detector was used without any excitation lamp.

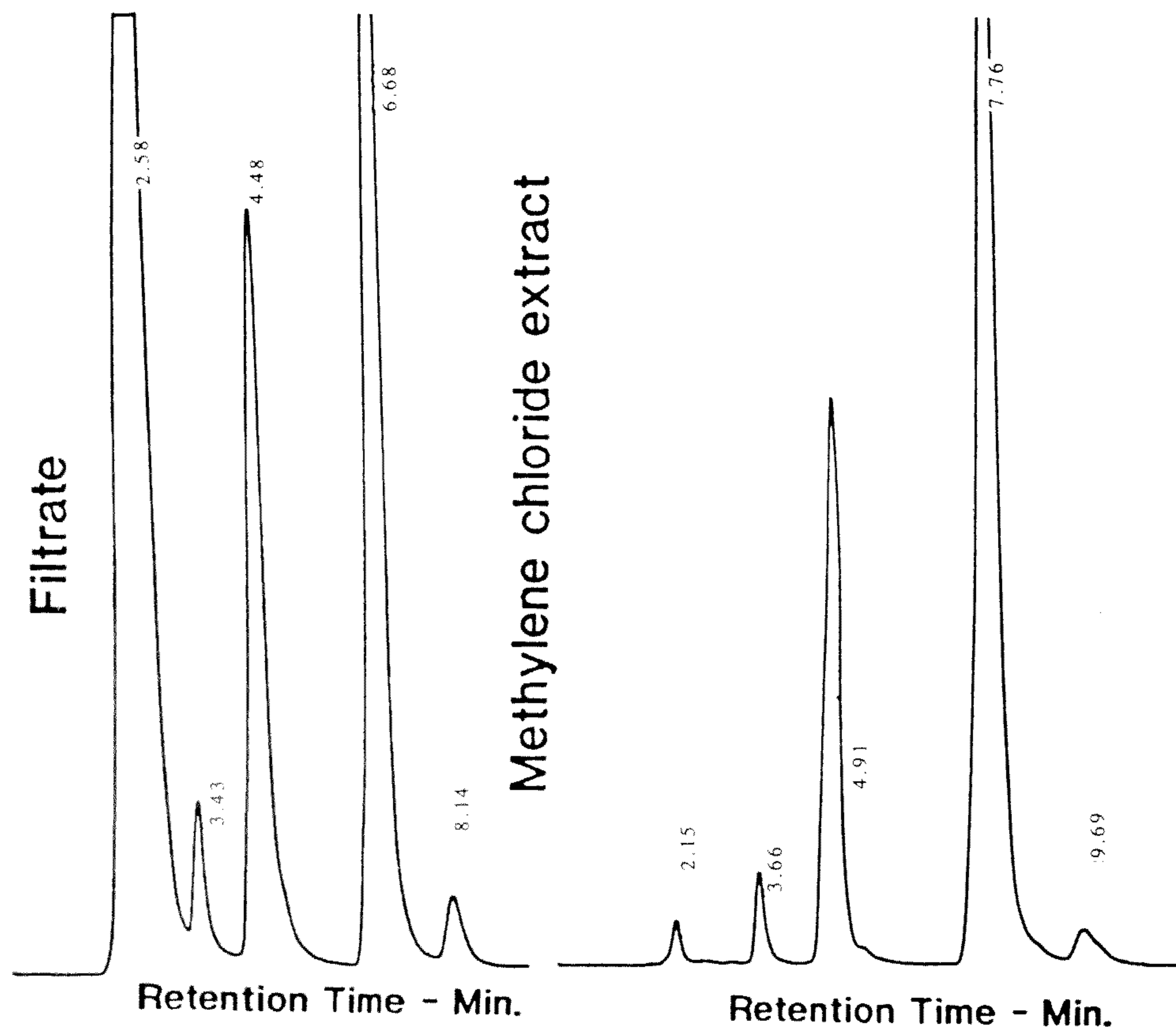
EPR detection of OH radical spin traps : A Fenton reaction scheme was used for the generation of hydroxyl radicals. This consisted of 75  $\mu$ l of 1 mM ferrous sulfate, 75  $\mu$ l of 1 mM diethylenetriaminepentaacetic acid (DETAPAC) and 75  $\mu$ l of 1 M hydrogen peroxide together with 50  $\mu$ l of 1  $\mu$ M DMPO (5,5-dimethyl-1-pyrroline N-oxide). A Varian X-band, E-109 EPR spectrometer, with 15 mW microwave power and 0.5 mT modulation, was used for the detection of OH-DMPO adducts.

Peroxide value determination: The Ameri-

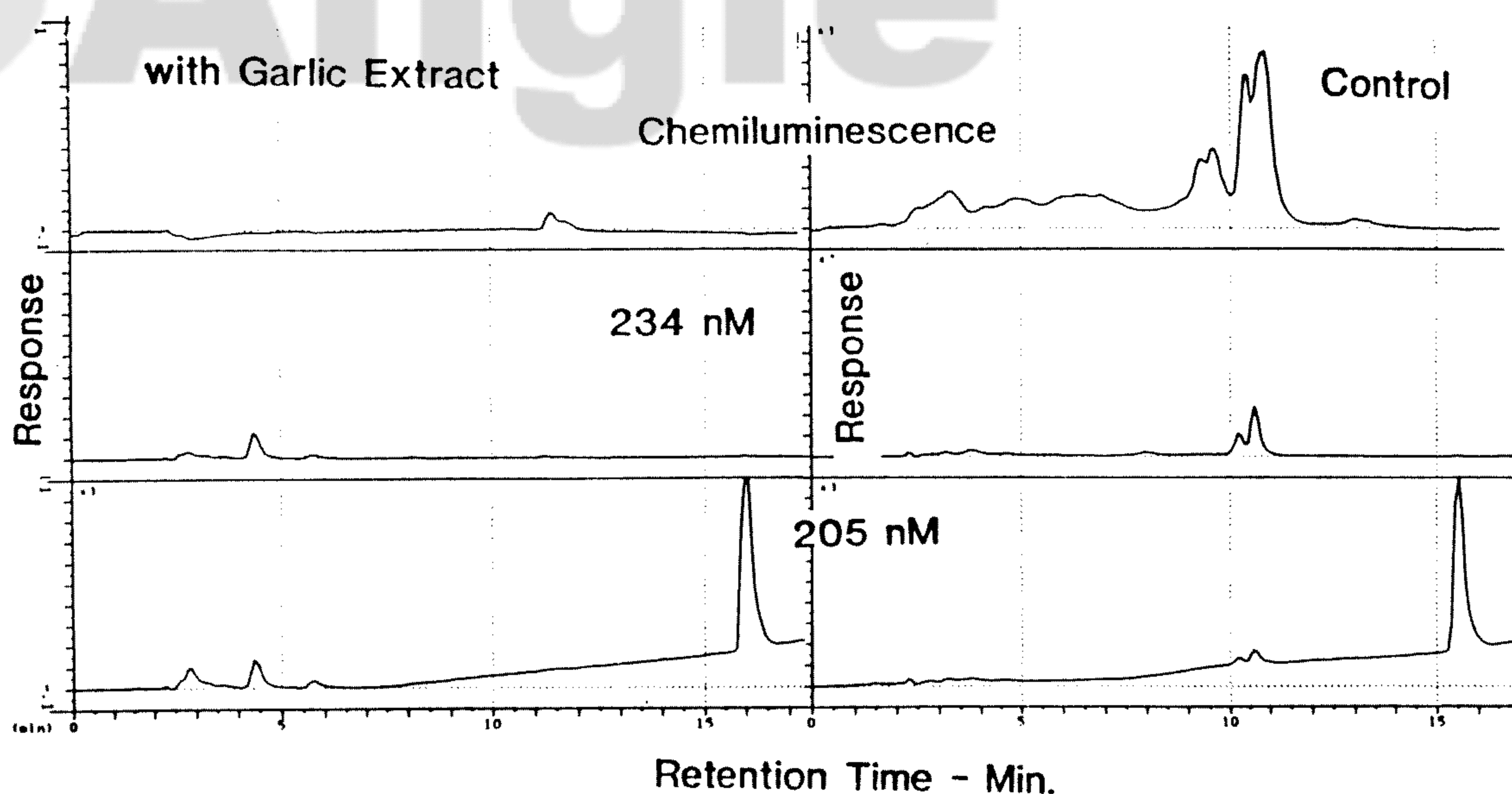
can Oil Chemists' Society method was used for the determination of the peroxide value (PV) <sup>(12)</sup>, except that the amount of material was 1 g instead of 5 g.

## RESULTS AND DISCUSSION

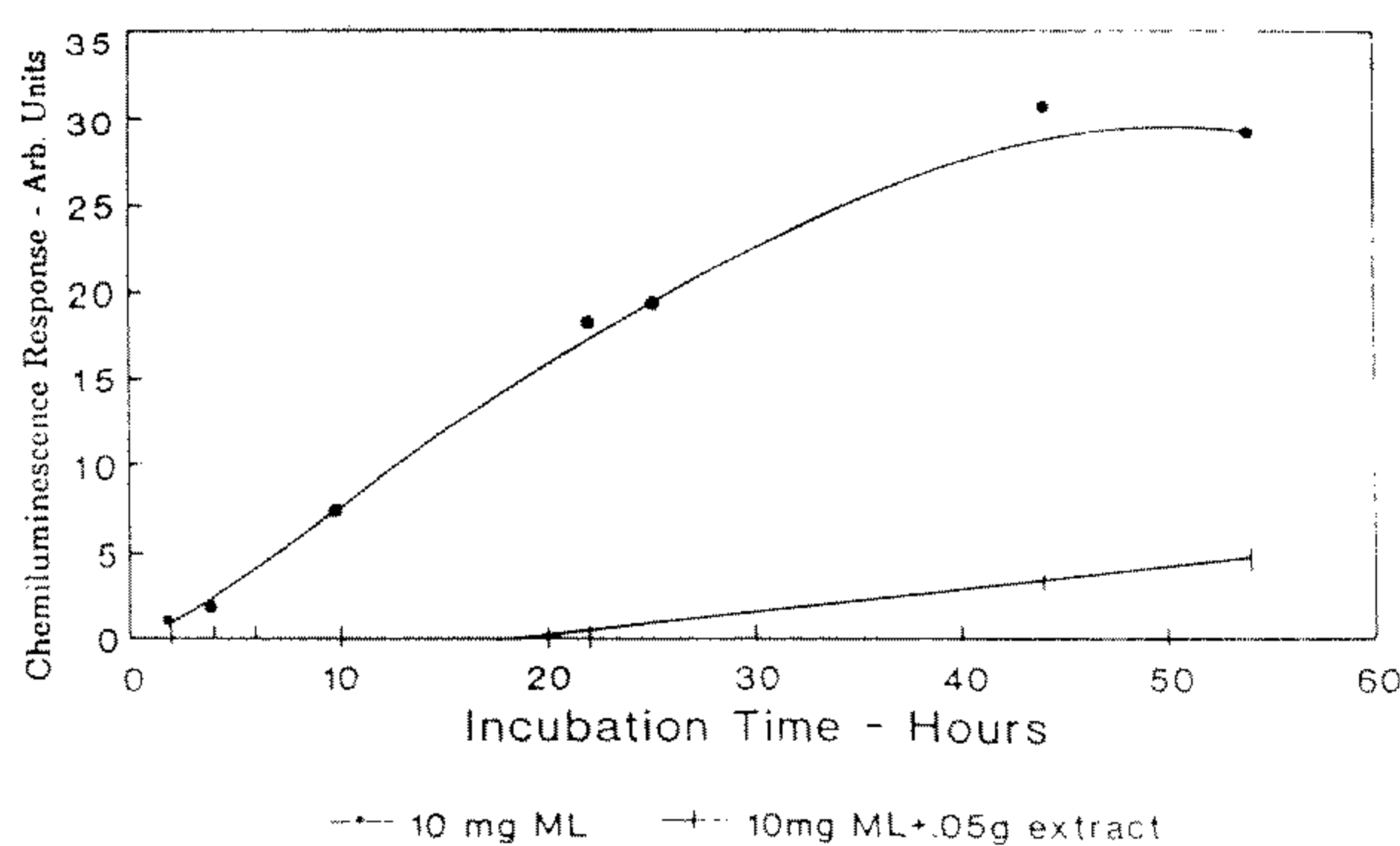
The HPLC chromatograms for both the filtrate and the methylene chloride extract from garlic are shown in Figure 2. The presence of allicin in the filtrates and extracts with a retention time of approximately 7 minutes has been verified with that of standard allicin. These filtrates and extracts were subsequently used to test for antioxidant activity. Figure 3 shows various detector responses, 234 nm and chemiluminescence for the ML hydroperoxides as well as 205 nm for the parent ML, with and without garlic ex-



**Figure 2.** HPLC chromatograms of garlic extract with reverse phase C-18, 5  $\mu$  column (see text for HPLC conditions).

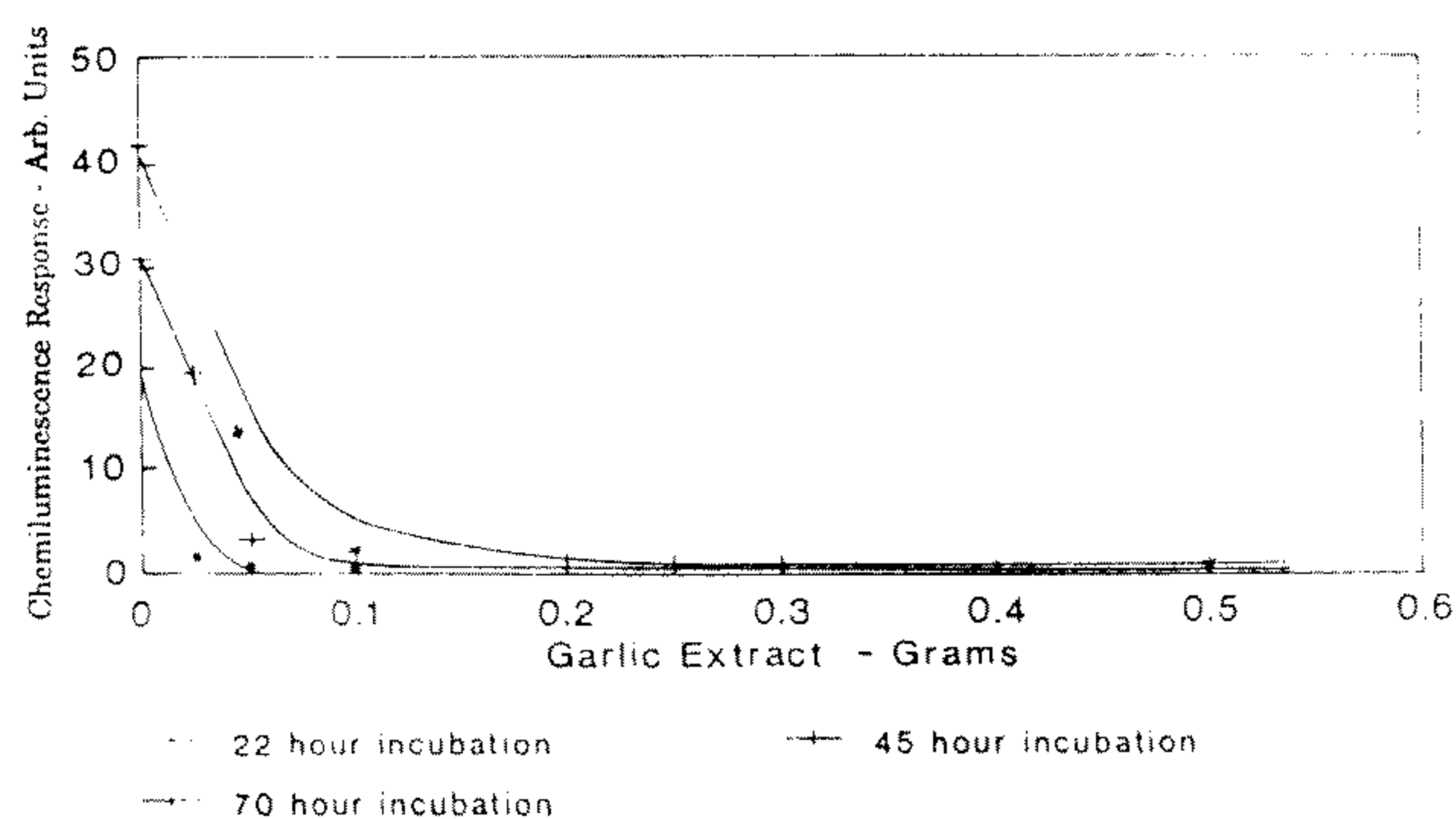


**Figure 3.** HPLC chromatograms of oxidized methyl linoleate with and without garlic extract, with chemiluminescence detection as well as with UV detection at 234 and 205 nm.



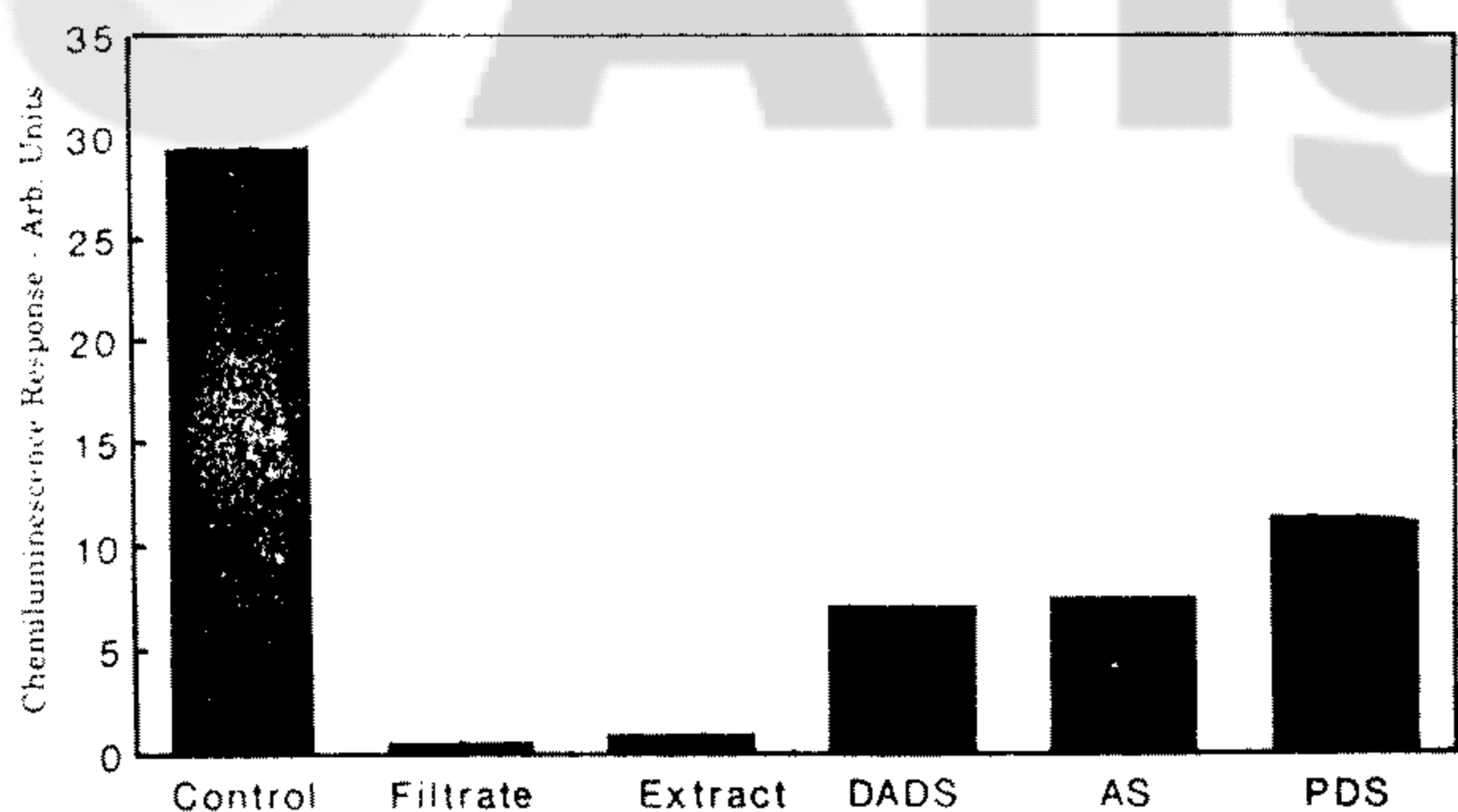
**Figure 4.** Growth of methyl linoleate hydroperoxide, detected by chemiluminescence, as functions of incubation time with and without garlic extract.

tracts. Hydroperoxide formation, as indicated by peaks associated in chemiluminescence, and 234 nm responses in Figure 3, has been significantly suppressed. Figure 4 shows the growth of ML hydroperoxide as functions of incubation time for ML alone and with garlic extract. Again, garlic extracts retarded the formation of ML hydroperoxide. Figure 5 shows that the reduction



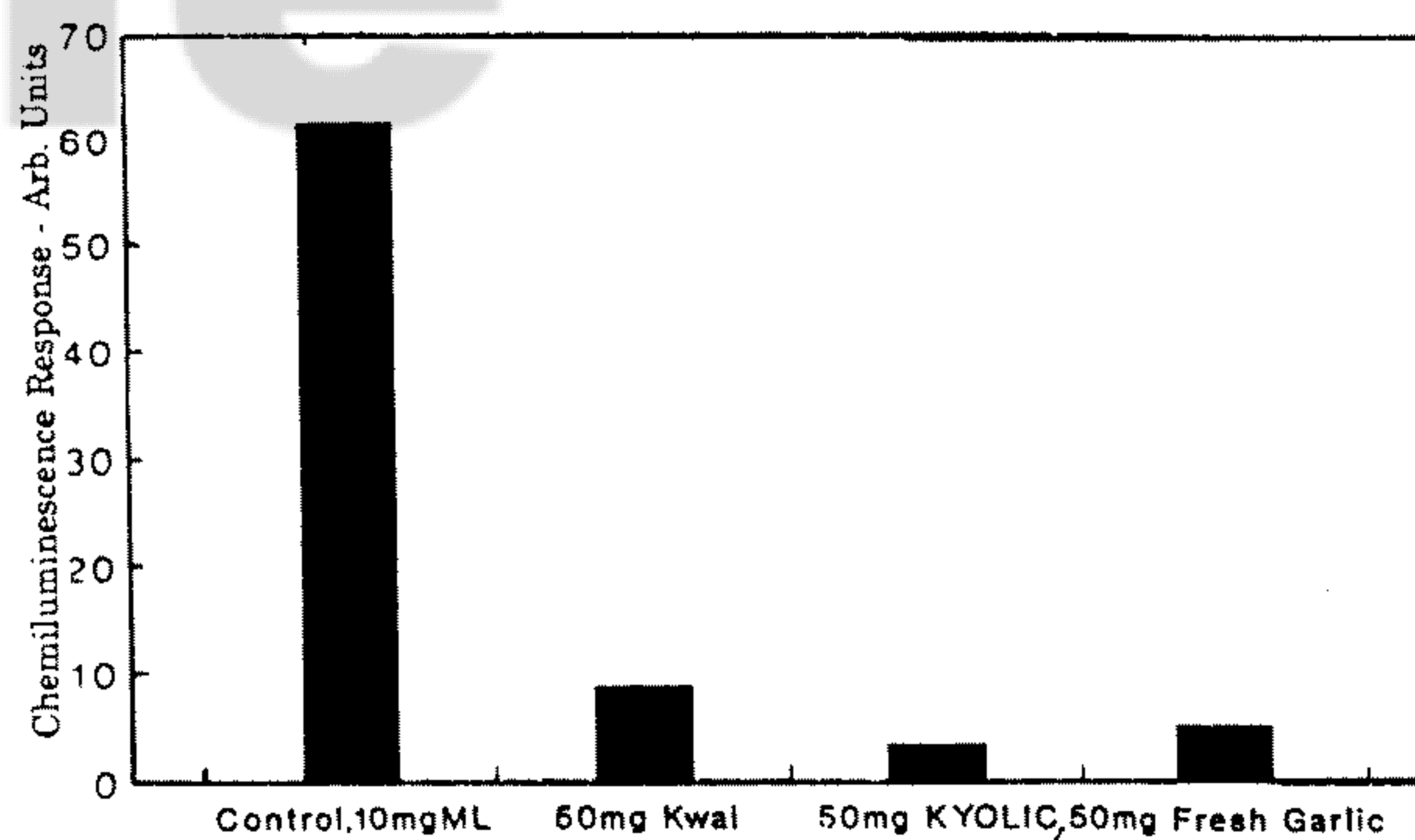
**Figure 5.** Concentration effects of garlic extract on the autoxidation of methyl linoleate, measured by HPLC-chemiluminescence of methyl linoleate hydroperoxides.

of ML hydroperoxide formation depends on the garlic concentration. Garlic extract, representing 0 to 500 mg of garlic, was incubated with 10 mg of ML in acetonitrile at 60°C and the chemiluminescence responses were measured after 22, 45 and 70 hours of incubation. The degree of protection against lipid oxidation is seen to be concentration dependent, similar to the protection



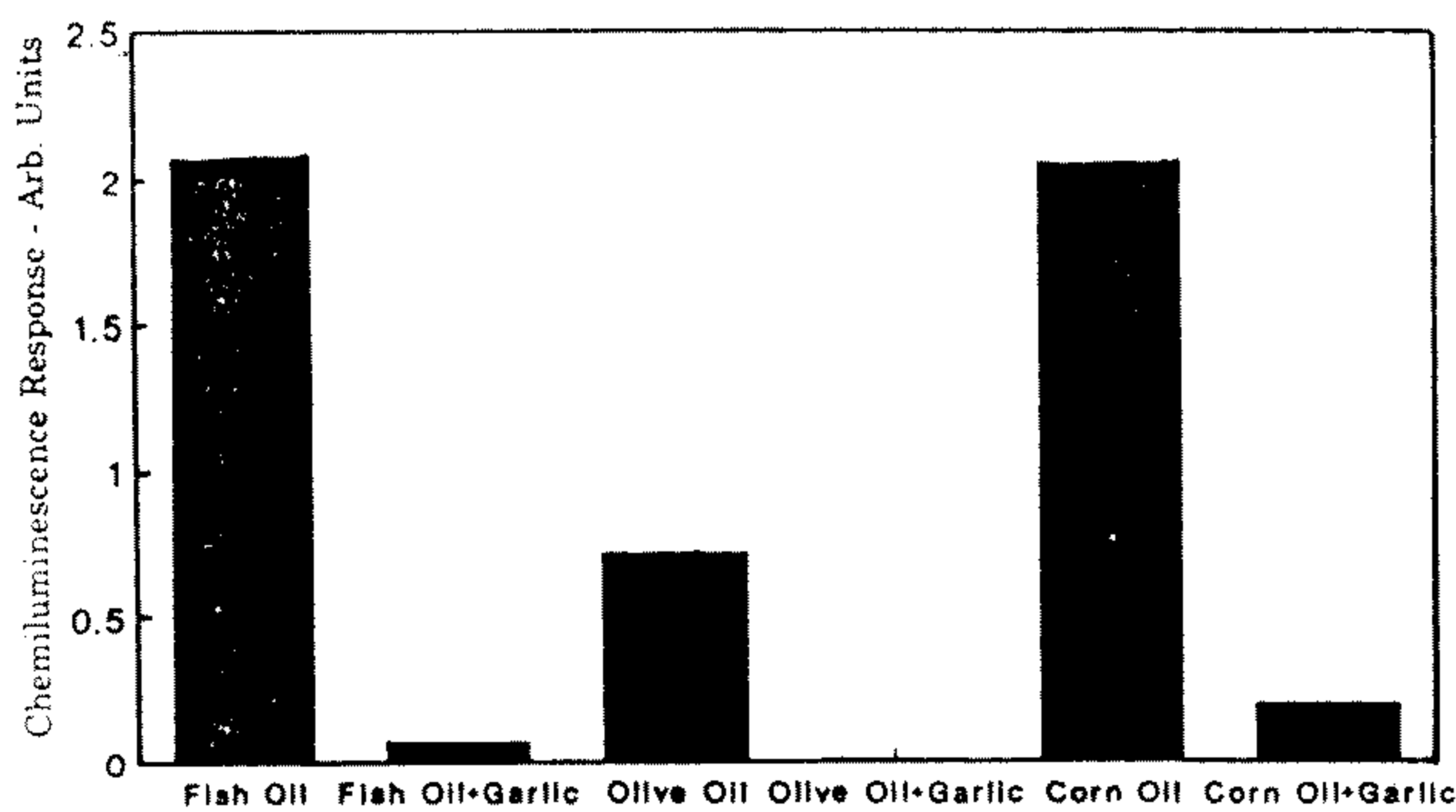
Incubation at 70°C for 45 hours  
DADS-Diallyl Disulfide; AS-Allyl Sulfide  
PDS-Propyl Disulfide

**Figure 6.** Comparison of antioxidant activities of garlic filtrate, garlic extract, diallyl disulfide, allyl sulfide, and propyl disulfide against the autoxidation of methyl linoleate, incubated at 70°C for 45 hours and measured by HPLC-chemiluminescence detection.



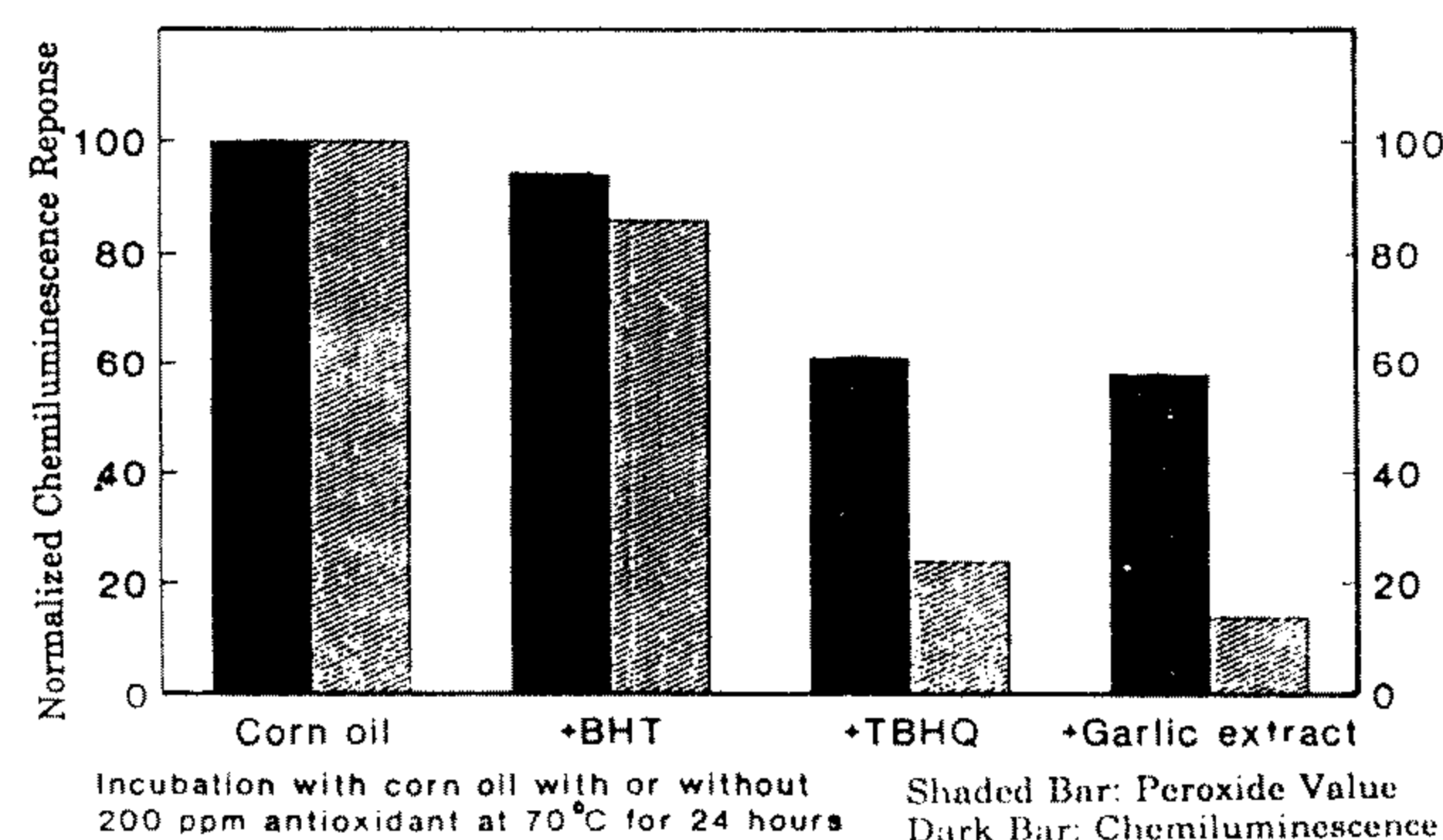
Incubation with methyl linoleate at 60°C for 24.5 hours

**Figure 7.** Comparison of antioxidant activities of various commercial garlic products against the autoxidation of methyl linoleate, incubated at 60°C for 24.5 hours and measured by HPLC-chemiluminescence detection.



Incubation at 70°C for 20 hours for fish oil and 90 hours for corn and olive oil

**Figure 8.** Effect of garlic on the autoxidation of corn, olive and fish oils by incubating the mixture at 70°C for 20 hours measured with HPLC-chemiluminescence detector.

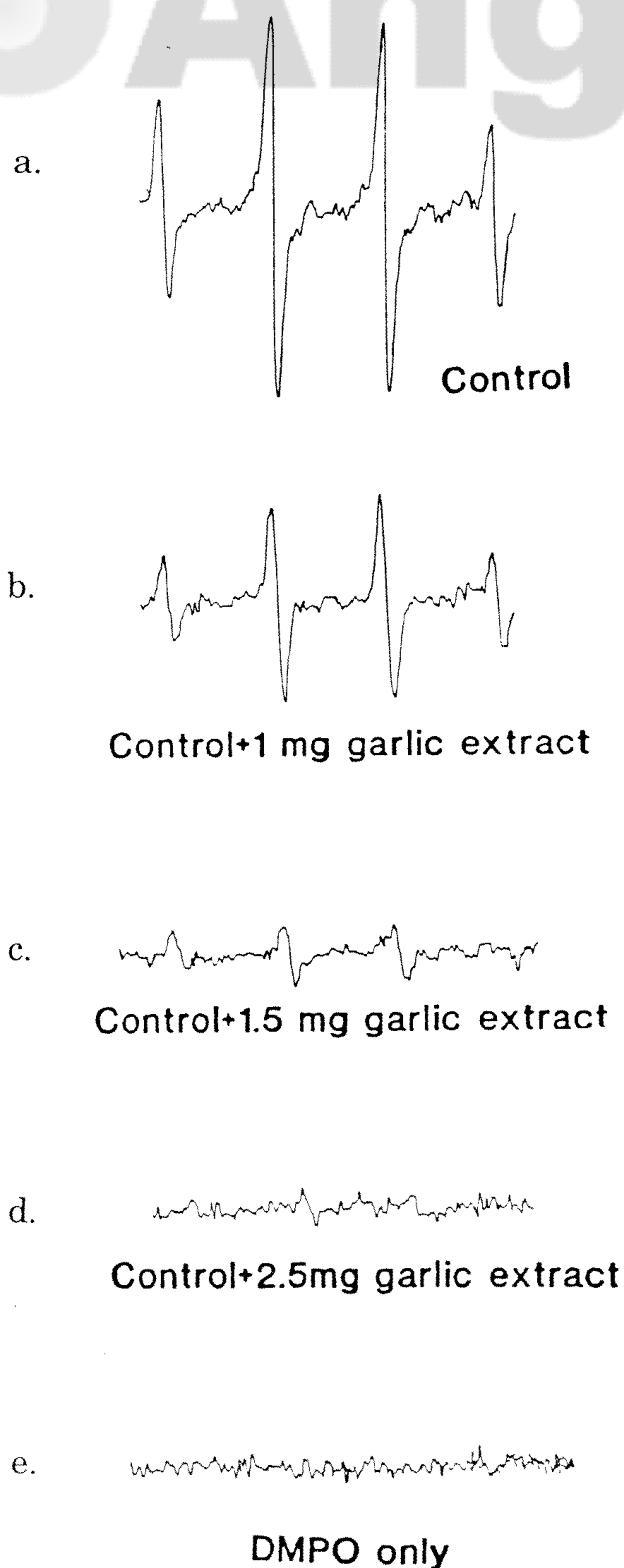


Incubation with corn oil with or without 200 ppm antioxidant at 70°C for 24 hours  
Shaded Bar: Peroxide Value  
Dark Bar: Chemiluminescence

**Figure 9.** Comparison of antioxidant activities of 200 ppm of garlic extract, BHT and TBHQ against the autoxidation of corn oil, incubating the mixture at 70°C for 24 hours, measured with HPLC-chemiluminescence detector.

rendered by the presence of some synthetic antioxidants. Figure 6 shows that not only garlic filtrate and methylene chloride extract showed antioxidant activity, but also other sulfur containing compounds such as diallyl sulfide, allyl sulfide and propyl disulfide had antioxidant activity. Various commercially available garlic products showed protection similar to fresh garlic extract, as seen in Figure 7. In order to test the effectiveness of garlic as an antioxidant in foods, garlic extract was added to fish oil, olive oil and

corn oil. Chemiluminescence responses were greatly reduced when garlic extract was added to these oils as seen in Figure 8. Garlic extract also compared favorably with respect to the reduction in hydroperoxide concentration when compared with other synthetic antioxidants in corn oil, as seen in Figure 9. Using PV measurements, similar results are also seen in Figure 9. Figure 10a shows the EPR signal for the OH-DMPO adduct and 10b to 10d show progressive suppression of the OH-DMPO signal as garlic



**Figure 10.** EPR signals for the OH-DMPO adduct generated by Fenton reaction as functions of increasing concentrations of garlic extract. ( a: control, b: control + 10 mg garlic extract, c : control + 1.5 mg garlic extract, d : control + 2.5 mg garlic extract and e: DMPO only)

concentration is increased. This demonstrates the competitive scavenging ability between garlic and DMPO spin trap towards OH radicals.

## CONCLUSION

Garlic showed antioxidant activity toward autoxidation of lipids and commercial oils in autoxidation, as measured by the HPLC-chemiluminescence techniques. These results were also verified by the conjugated diene measurement and PV values. Garlic extract also exhibited OH radical scavenging ability. The decrease in OH radical available to be trapped by a DMPO spin trap reagent was demonstrated by the smaller EPR spin adduct signal.

## REFERENCES

1. Block, E. 1985 The Chemistry of Garlic and Onions. *Scientific American*. 252 : 114-119.
2. Fenwick, G.R., and Hanley, A.B. 1985. The Genus *Allium*. Part 1, Critical Reviews in Food Science. 22 : 199-271
3. Kourounakis, P.N., and Rekkas, E.A. 1991. Effect on active oxygen species of alliin and allium sativum (garlic) powder. *Research Communications in Chemical Pathology and Pharmacology*. 74(2): 249-252.
4. Belman, S. 1983. Onion and Garlic Oils Inhibit Tumor Promotion. *Carcinogenesis*. 4: 1063-1065.
5. Sporn, V.L., Mott, A.W. and Wattenberg, L.W. 1986. Effects of allyl methyl trisulfide on glutathione S-transferase activity and BP-induced neoplasia in the mouse. *Nutrition and Cancer*. 8 : 211-215.
6. Wargovich, M.J. 1987. Diallyl sulfide, a flavor component of garlic (*Allium sativum*) inhibits dimethylhydrazine-induced colon cancer. *Carcinogenesis*. 8: 487-489
7. Niukian, K., Schwartz, J. and Shklar, G. 1987. Effects of onion extracts on the development of hamster buccal pouch carcinomas as expressed in tumor burden. *Nutrition and*

Journal of Food and Drug Analysis 1993. 1(4)

- Cancer. 9: 171-176.
8. Sporn, V.L., Barany, G. and Wattenberg, L.W. 1988. Effects of organosulfur components from garlic and onion on benzo[*a*]pyrene-induced neoplasia and glutathione S-transferase activation in the mouse. *Carcinogenesis*. 9: 131-134.
9. Wargovich, M.J., Woods, C., Eng, V.W.S., Stephens, L.C., and Gray, K.N. 1988. Chemoprevention of nitrosomethylbenzylamine-induced esophageal cancer in rats by the thioether, diallyl sulfide. *Cancer Research*. 48 : 6872-6875.
10. Yang, G.C. 1992. Detection of Lipid Hydroperoxides by High Performance Liquid Chromatography Post-Column Chemiluminescence and High Performance Liquid Chromatography Post-Column Iodometric Techniques; *Trends in Food Science and Technology*. 113(1): 15-18.
11. Rosenthal, I., Krishna, C.M., Yang, G. C., Kondo, T. and Reisz, P. 1987 A New Approach for EPR Detection of Hydroxyl Reaction by Radicals with Sterically Hindered Cyclic Amines and Oxygen. *FEBS Letters*. 222(1): 75-78.
12. AOAC. 1970. Official Methods of Analysis, 11th ed., Association of Official Analytical Chemists. Washington, DC, USA, pp. 445-446.

## 以光學活性靜相管柱分析光學活性藥物

GEORGE C. YANG (楊覺智), PARVIN M. YASAE AND SAMUEL W. PAGE

*Center for Food Safety and Applied Nutrition, Food and Drug Administration,  
200C St. S.W., Washington, D.C. 20204, U.S.A.*

### 摘 要

以最近發展出測定油脂氧化過程中之初期中間產物(油脂過氧化物)的技術來評估新鮮大蒜精及市售大蒜產品之抗氧化作用,此評估系統採用附有化學冷光測定器之逆相層析管柱。大蒜製品的抗氧化能力則與人工合成的抗氧化劑進行比較。如同

許多人工合成之抗氧化劑,大蒜精對保護油脂避免氧化的作用是決定於其濃度。此外,大蒜精亦被發現能消除氫氧自由基,此可由當有氫氧自由基存在時,spin trap adduct的減少得以驗證。